

! INFO !

Do not charge the battery of the towing vehicle and/or towed vehicle directly via the socket.

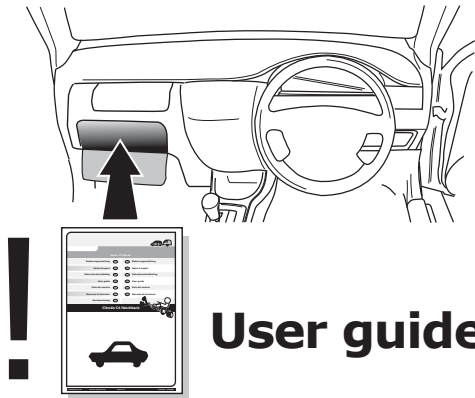

User guide

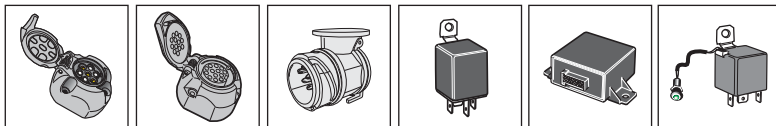

SPARE PARTS

www.ecs-electronicsuk.co.uk



Partnr.: OP-057-BLU

User Guide

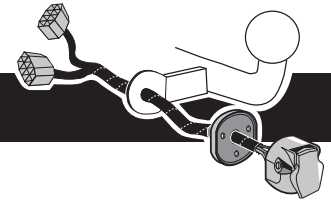



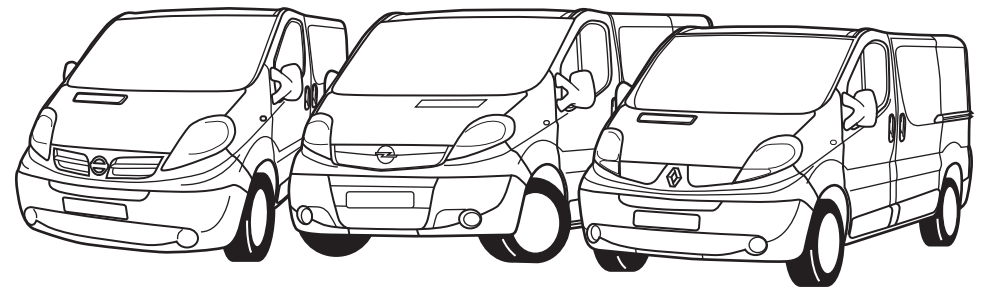

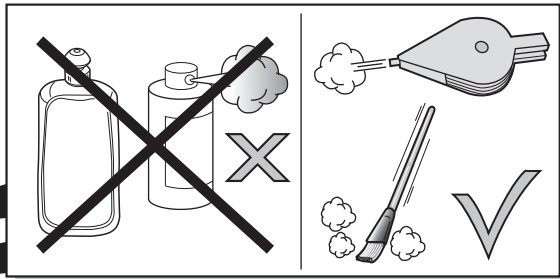
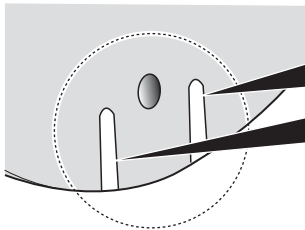
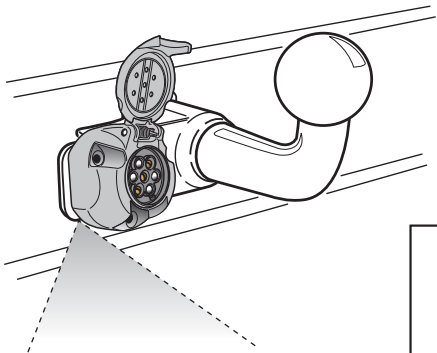
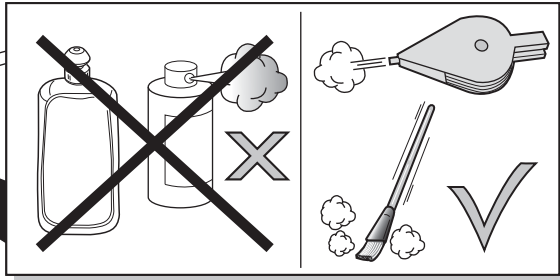
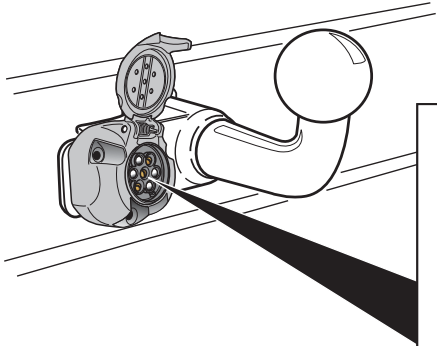
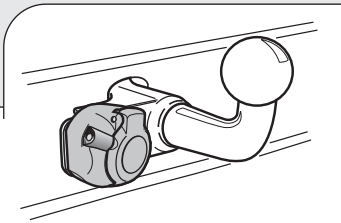

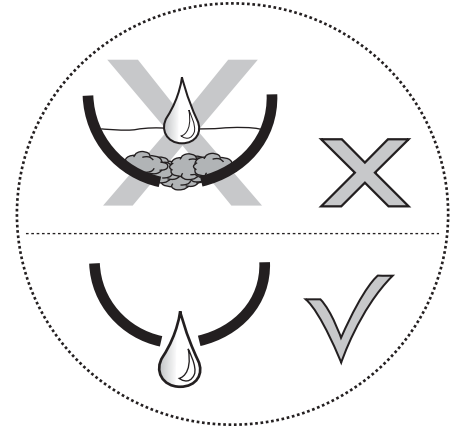
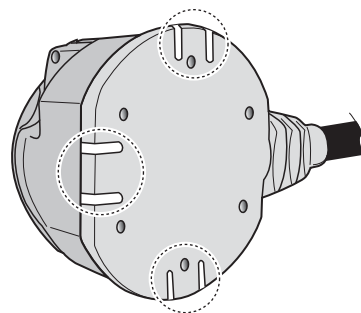
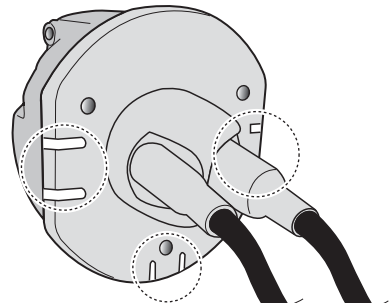
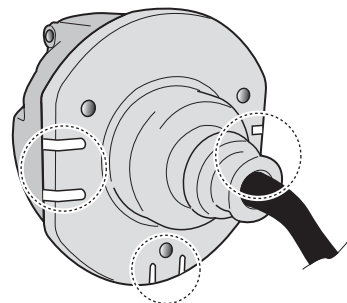
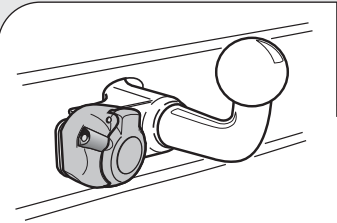
Opel Vivaro 08/2006 >> 07/2014
Renault Trafic 10/2006 >> 07/2014
Nissan Primastar 10/2006 >> 08/2016







SOCKET CONNECTION

DIN/ISO 1724							
	1/L	2	3/31	4/R	5/58-R	6/54	7/58-L
Pmax	21W	2x21W		21W	52W	3x21W	52W
Colour	Yellow	Blue	White	Green	Brown	Red	Black